



Multinorm MI 6201
FonS MI 6301
Poly MI 6401
User Manual

Version 1.1, Code no. 20 751 260



Mark on your equipment certifies that this equipment meets the requirements of the EU (European Union) concerning safety and interference causing equipment regulations

No part of this publication may be reproduced or utilised in any form or by any means without permission in writing from METREL.

Table of contents

1	Introduction	6
1.1	General information	6
1.2	Accessories	6
1.2.1	Standard accessories	6
1.2.2	Optional accessories	6
1.3	Warnings	6
1.4	Inserting battery cells into the instrument	7
1.5	Power supply and battery charging	8
1.6	New battery cells or cells unused for a longer period	9
1.7	Periodic calibration	9
1.8	Cleaning	9
1.9	Service	10
1.10	Standards applied	10
2	Instrument description	11
2.1	Instrument front panel	11
2.2	Instrument bottom	12
2.3	Instrument input/output ports	13
3	Measurements	14
3.1	Normal measuring mode (Measurements)	14
3.1.1	Overview	14
3.1.2	Displaying all parameters	15
3.1.3	Hold function	16
3.1.4	Min, Avg, Max, Cur values	17
3.1.5	Displaying single parameter	18
3.1.6	Save function	18
3.2	Logger mode (Measurements)	18
3.2.1	Overview	18
3.2.2	Description	18
3.2.2.1	Entering logger mode	18
3.2.2.2	Back to normal mode	19
3.3	Normal measuring mode (Sound)	20
3.4	Logger mode (Sound)	20
3.4.1	Overview	20
3.4.2	Description	20
3.4.2.1	Entering logger mode	20
3.4.2.2	Back to normal mode	20
4	Memory management	21
4.1	Overview	21
4.2	Saving measurement records	21
4.2.1	Save menu	23
4.2.2	Rename menu	23
4.3	Recalling normal/multipoint measurement results	24
4.3.1	Results recall menu	24
4.3.2	Results find menu	25
4.3.3	Results view menu	25
4.3.4	Clearing measurement records	25

4.4	Recalling logged measuring records	26
4.4.1	Loggers recall menu	26
5	Settings	27
5.1	Overview	27
5.2	Settings menu	27
5.3	Measurements menu	27
5.3.1	Units menu	27
5.4	Memory clear menu	28
5.4.1	Memory clear menu	28
5.5	Logger menu	28
5.5.1	General	28
5.5.2	Logging interval	28
5.5.3	Logger clear menu	29
5.6	Other menus	30
5.6.1	Language menu	30
5.6.2	Date & time menu	30
5.6.3	Battery menu	31
5.6.4	Contrast menu	31
6	Technical data	32
6.1	Instrument	32
6.1.1	General	32
6.1.2	Universal measuring port 1	32
6.1.3	Universal measuring port 2	33
6.1.4	Thermocouple measuring port type K	33
6.2	Probe adapter (A 1144)	33
6.2.1	General	33
6.2.2	Instrument side:	33
6.2.3	Probe side:	33

1 Introduction

1.1 General information

Multinorm MI 6201, **FonS** MI 6301 and **Poly** MI 6401 is a portable multi functional handheld instrument for measuring air parameters, sound and light measurements and more.

Instrument features

- All measuring probes can be connected simultaneously.
- Specially designed housing for easy connection of measuring probes directly to the instrument.
- Optional probe connection with prolongation cable (illuminance, luminance, sound) or telescopic rod (air velocity, relative humidity, air temperature).
- In built memory for storing/logging measured parameters.
- USB interface for communication with a PC.
- In built rechargeable battery.
- 160 x 160 dots graphical LCD with backlight.
- Can be mounted on a tripod.
- Automatic switch-off when not used for 10 minutes.

1.2 Accessories

1.2.1 Standard accessories

See attached sheet for a list of standard accessories.

1.2.2 Optional accessories

See attached sheet for a list of optional accessories that are available on request from your distributor.

1.3 Warnings

To ensure a high level of operator's safety while carrying out various measurements and tests using the instrument, as well as ensuring that the test equipment remains undamaged, it is necessary to consider the following general warnings:



The test equipment is intended for use in low voltage environment only !
Service is allowed to be carried out only by an authorised person!
Use only standard or optional test accessories supplied by your distributor !

1.4 Inserting battery cells into the instrument

1. Make sure that the power supply adapter and all probes are disconnect and the instrument is off.
2. Insert battery cells as shown in Picture 1.1. Insert the cells correctly, otherwise the instrument will not operate and the batteries could be discharged or damaged.

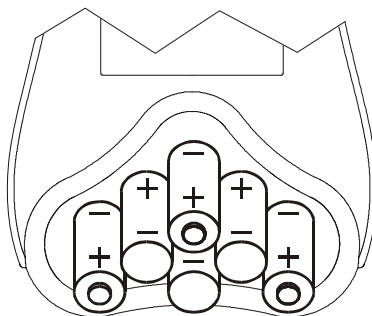

Picture 1.1 Battery placement

3. Turn the instrument with the display lower than the battery holder (Picture 1.2) and put the cover on the battery cells.

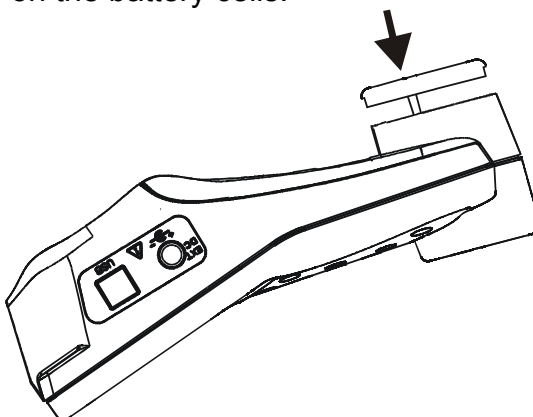

Picture 1.2: Closing the battery holder

4. Screw the cover on the instrument.

If the instrument is not used for a long period of time remove all battery cells from the battery holder. The enclosed cells can supply the instrument for approx. 8 hours in worst case (microclimatic probe connected and measuring). This time is extended if air velocity measurement is switched off.



Warnings!

- **When battery cells have to be replaced, turn off the instrument before opening battery cover.**
- **Use only power supply adapter delivered from manufacturer or distributor of the equipment to avoid possible fire or electric shock.**



- Rechargeable NiCd or NiMH battery cells (size AA) are recommended. The charging time and the operating hours are given for cells with a nominal capacity of 2100 mAh.
- Do not use standard batteries while power supply adapter is connected, otherwise they may explode!
- Do not mix battery cells of different types, brands, ages, or charge levels.
- When charging battery for the first time, make sure to charge it for at least 16 hours (24 hours recommended) before switching on the instrument.
- During very long charging (>16 h) in hot (40 °C) environment the battery holder screw might reach maximum allowed temperature for metal part of handle. In such environment it is advisable not to touch the battery cover during or immediately after the charging.

1.5 Power supply and battery charging

Power can be supplied to the instrument from:

- USB input. Recommended means for operating the instrument from an USB input is for data transfer.
- Battery cells. Recommended means for operating the instrument from Battery cells is for measuring.
- External power supply. Recommended means for operating the instrument from an external power supply is for battery charging.

Status of the battery cells is indicated by the battery sign at the upper left corner of the display (see Picture 2.1). Lines in the battery sign indicates the plenitude of the cells.

-  If the battery sign is broken it indicates that battery cells are not present in the instrument.
-  Battery cells are empty.
-  Battery cells are full.

If the battery sign is animate from empty to full it indicates the charging of the battery cells. In build charger monitors the charging process and switch off charging when battery cells are full.

If the instrument is connected to external power supply the battery cells are charged in all modes of the instrument. If the instrument is connected to USB master device with capability of supply the power to the host the battery cells are charged but only in charging mode (before switch on or after switch off the instrument).

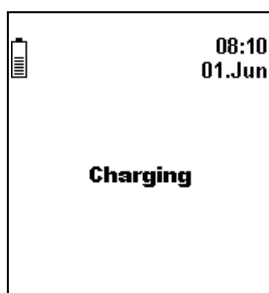

Picture 1.3: Charging mode

1.6 New battery cells or cells unused for a longer period

Unpredictable chemical processes can occur during charging of new battery cells or cells that were unused for a longer period (more than 3 months). Ni-MH and Ni-Cd battery cells are affected to capacity degradation (sometimes called as memory effect). As a result the instrument operation time can be significantly reduced.

Recommended procedure for recovering battery cells:

Procedure	Notes
Completely charge the battery.	At least 16h with in-built charger.
Completely discharge the battery.	Can be performed with normal work with the instrument.
Repeat the charge / discharge cycle for at least two times .	Four cycles are recommended.

Complete discharge / charge cycle is performed automatically for each cell using external intelligent battery charger.

Notes:

- The charger in the instrument is a pack cell charger. This means that the battery cells are connected in series during the charging. The battery cells have to be equivalent (same charge condition, same type and age).
- One different battery cell can cause an improper charging and incorrect discharging during normal usage of the entire battery pack (it results in heating of the battery pack, significantly decreased operation time, reversing polarity of defective cell,...).
- If no improvement is achieved after several charge / discharge cycles, then each battery cell should be checked (by comparing battery voltages, testing them in a cell charger, etc). It is very likely that only some of the battery cells are deteriorated.
- The effects described above should not be mixed with normal decrease of battery capacity over time. Battery also loses some capacity when it is repeatedly charged / discharged. The actual decrease of capacity versus number of charging cycles depends on battery type and is provided in the technical specification from battery manufacturer.

1.7 Periodic calibration

It is essential that the instrument and its probes are calibrated regularly. We recommend that calibration of the instrument and its probes is carried out once per year if there are no different recommendations for specific probe. Please contact your Metrel distributor for further information on calibration.

1.8 Cleaning

Use soft patch, slightly moistened with soap water or alcohol, to clean the surface of the instrument and leave it to dry totally, before using it.

Notes!

- Do not use liquids based on petrol or hydrocarbons!
- Do not spill cleaning liquid over the instrument!

1.9 Service

For repairs under or out of warranty time please contact your Metrel distributor for further information.

Name and address of manufacturer:

METREL d.d.

Ljubljanska cesta 77

SI-1354 Horjul

Tel.: +386 1 75 58 200, fax.: +386 1 75 49 226, +386 1 75 49 206

<http://www.metrel.si>

E-mail: metrel@metrel.si

1.10 Standards applied

The instrument conforms to the following standards:

EN 61010-1	Safety
EN 61326	EMC
DIN 5032 P1	Photometry; methods of measurement
DIN 5032 P2	Photometry; Operation of electric lamps and measurement of the respective quantities
DIN 5032 P3	Photometry; Terms of measurement on gas luminaires
DIN 5032 P4	Photometry; Measurement of luminaires
DIN 5032 P6	Photometry; Photometers; Concepts, characteristics and their designation
DIN 5032 P7	Photometry; Classification of illuminance meters and luminance meters
EN 60751	Industrial platinum resistance thermometer sensors
EN 60584-1	Thermocouples - part 1: reference tables (IEC 60584-1:1995);
EN 12599	Ventilation for buildings - Test procedures and measuring methods for handling over installed ventilation and air conditioning systems
EN ISO 7726	Ergonomic of thermal environment - Instruments for measuring physical quantities
ISO 10526	CIE STANDARD colorimetric illuminants
ISO 10527	CIE STANDARD colorimetric observers

2 Instrument description

2.1 Instrument front panel

The instrument has 13 keys and a graphical display with 160x160 dots. Display is divided into three parts or windows.

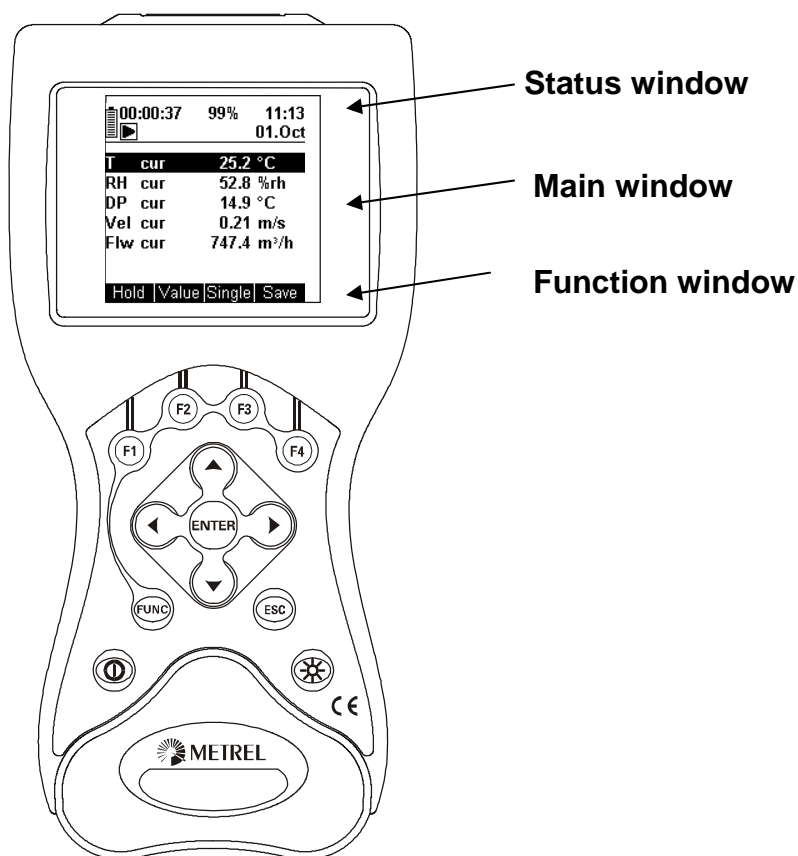

Picture 2.1: Instrument front panel

Status window:

Here are some general information about date, battery status, duration of the measurement, play / stop / pause / record icons and various warnings.

Main window:





Here are measurement results or various menus.

Function window:

Here are descriptions of function keys.

Keys:

- , : switch between parameters, between building and room, etc.
- , : change certain values – room number, interval, etc.
- : starts or stops measurement, confirms changes in settings, etc.
- to : perform action written on the display above particular function key.

-  : changes the set of function keys.
-  : returns to the previous menu.
-  : toggles backlight.
-  : turns on/off the instrument.

2.2 Instrument bottom

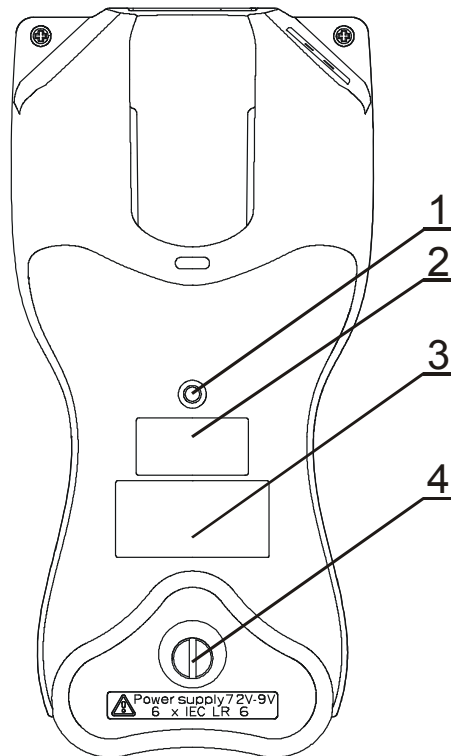

Picture 2.2: Instrument bottom

1. Nut for mounting a tripod adapter
2. Serial number
3. Information label
4. Battery compartment

2.3 Instrument input/output ports

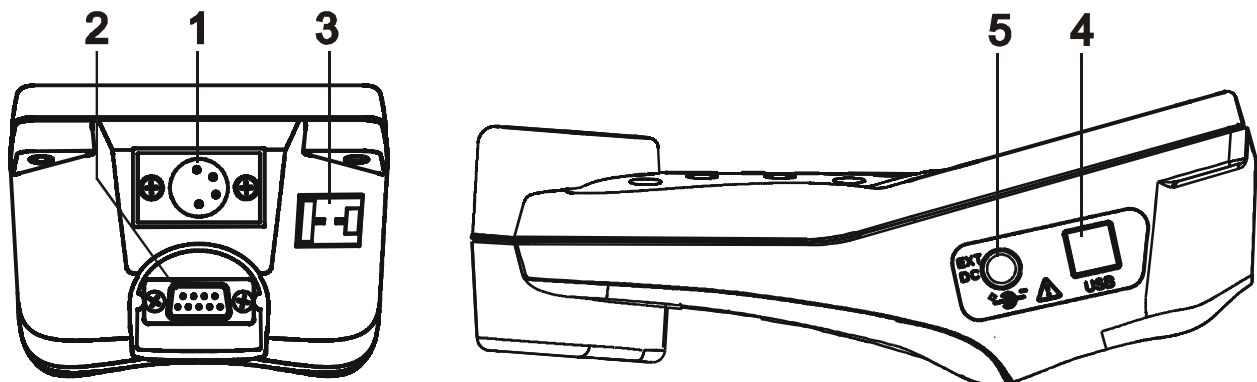

Picture 2.3: Instrument input/output ports

1. Universal measuring port 1

Illuminance probe type B	A1092
Luminance probe type B	A1132
Black globe thermometer	A1131
Sound probe class 1	A1146
Sound probe class 2	A1151

2. Universal measuring port 2

Probe adapter	A1144
---------------	-------

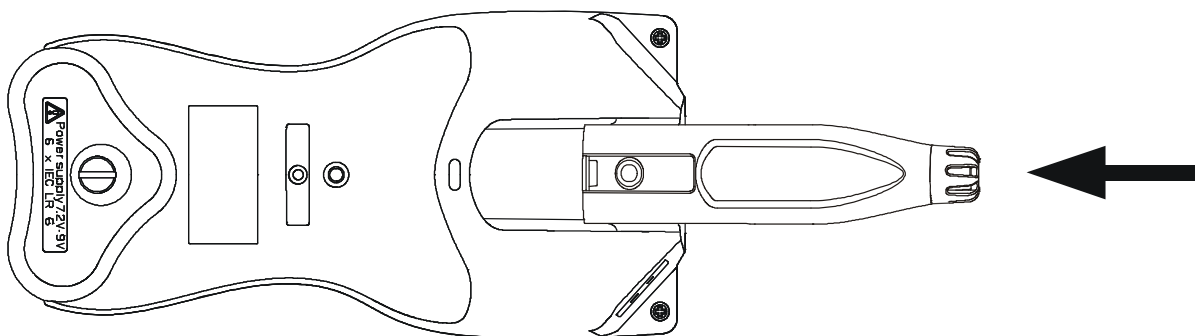

Picture 2.4: Proper adapter connection to universal measuring port 2

Probe adapter supports the following probes:

Microclimatic probe	A1091
Temperature and humidity probe	A1127

3. Thermocouple measuring port type K

Thermocouple probe type K	A1128
---------------------------	-------

4. USB communication interface

5. Power supply adapter input

3 Measurements

When the instrument is switched on it always starts in the **Main menu**, which is shown in Picture 3.1. Here one can choose between five main options.

- **Measurements (supported by Multinorm MI6201/Poly MI6401)**: in this option the instrument is measuring all parameters from the probes which are connected to the instrument.
- **Sound (supported by Multinorm MI6201/FonS MI6301)**: this option (together with sound probe A1146 or A1151) activates sound level meter.
- **Results Recall/Clear**: in this option saved measurement results can be recalled or cleared.
- **Loggers Recall/Clear**: in this option recorded loggers can be cleared or their statistics can be recalled.
- **Settings**: in this option various settings of the instrument can be changed.
- **Help**: in this option a brief help about handling the instrument is displayed.

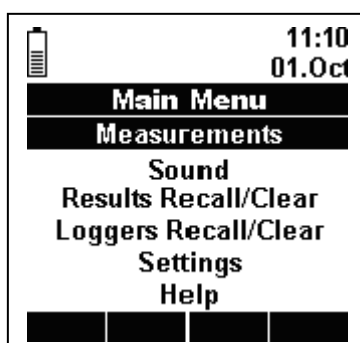

Picture 3.1: Main menu

Instrument has two different measuring modes under **Measurements** and **Sound** option: normal and logger measuring mode.

3.1 Normal measuring mode (Measurements)

3.1.1 Overview

This measuring mode is intended to collect and handle measuring data from all probes that could be connected to different instrument measuring ports. For each parameter the instrument can offer:

Value	Abbreviation
current	cur
minimum	min
maximum	max
average	avg
start measurement	Start
stop measurement	Stop

Tabela 3.1: Value table

Normal measuring mode has two sets of function keys. First set consists of **Hold**, **Value**, **Single** and **Save**, and the second set of **Logger** and some custom keys for different parameters and probes.

For probe description and its connection to the instrument see user manual for particular probe.

3.1.2 Displaying all parameters

To enter normal measuring mode select **Measurements** option in the **Main menu** and press the  key. Picture 3.2 shows display before the measurement is started. The probes are already plugged in the corresponding measuring ports. Measurements are stopped, which is indicated with stop icon and also with dashes instead of values. All parameters that can be measured with currently connected probes are in the main window.

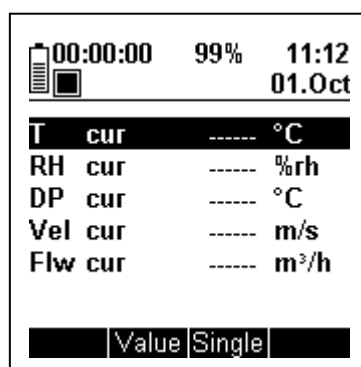

Picture 3.2: Normal mode – microclimatic probe connected, measurements stopped

The instrument starts and stops measuring by pressing the  key. The instrument checks which probes are plugged-in approximately once every second. If a new probe is plugged-in during the measurement, measurements are stopped and reset.

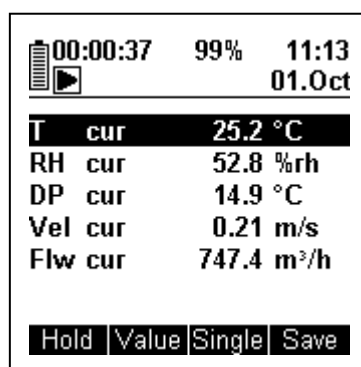

Picture 3.3: Normal mode – microclimatic probe connected, measurements running

If there are no probes connected there is **NO PROBE** caption displayed in the main window of the display (Picture 3.4).

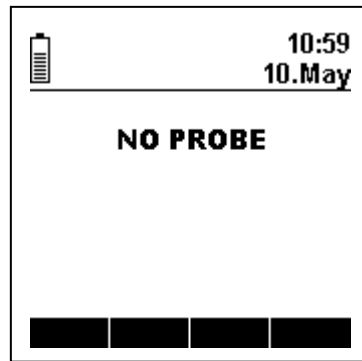

Picture 3.4: Normal mode – no probe connected

3.1.3 Hold function

If the F1 (**Hold**) key is pressed when the instrument is measuring, the momentary **Min**, **Avg**, **Max** or **Cur** values are retained. Measurements are proceeding normally meanwhile in the background. Note that the F4 (**Save**) key like the **ENTER** key stops measurement during hold mode. To return to normal display mode press F1 (**Hold**) again. In the

Picture 3.5 graphical representation of the **Hold** function is shown.

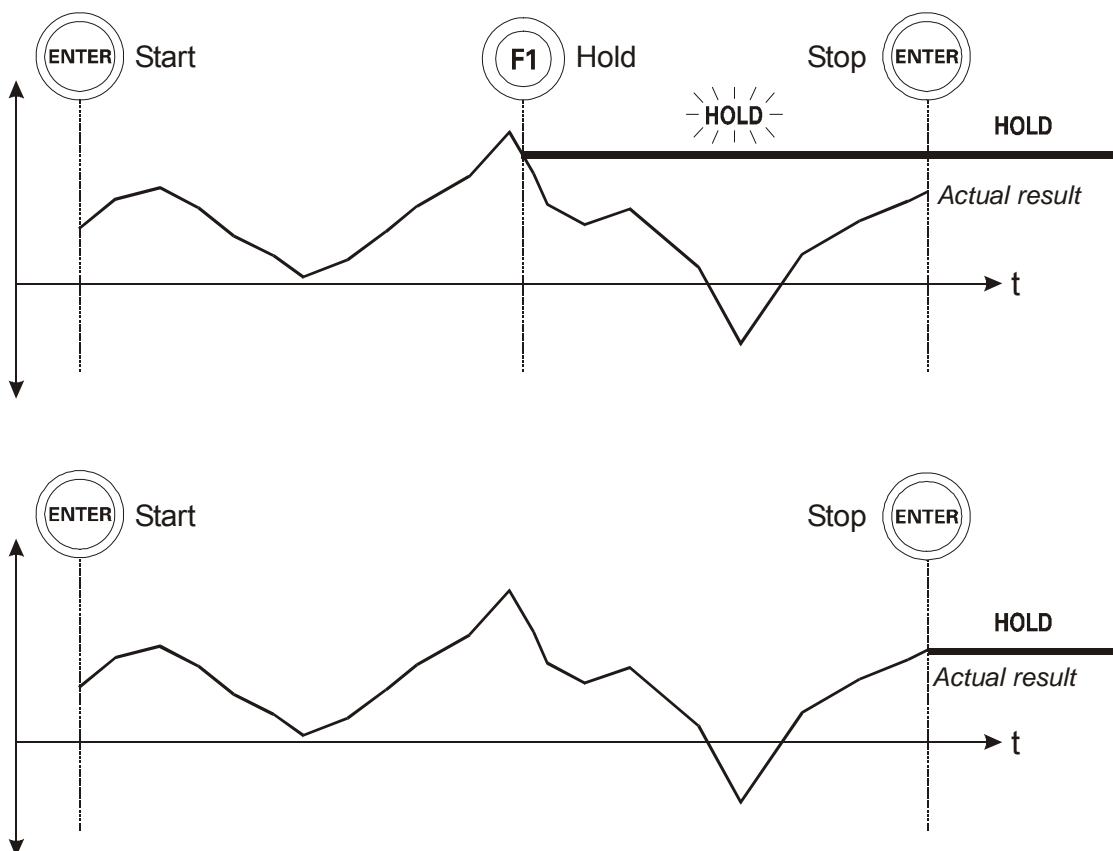

Picture 3.5: Hold function

3.1.4 Min, Avg, Max, Cur values

Instrument samples current values of measured parameters from all connected probes approximately once every second. While measuring, the instrument calculates average and remembers the maximum and the minimum value for each parameter (physical quantity) during the measurement. **Min**, **Avg** and **Max** values for all probes are reset at the start of the measurement or when a new probe is connected to the instrument.

One can switch between **Min**, **Avg**, **Max** and **Cur** values with the F2 (**Value**) key. This key switches between **Min**, **Avg**, **Max** and **Cur** values for all probes connected. It is also possible to switch only value for one probe with \odot or \ominus key. Note that you can switch between these values also during measurement, and not only after the measurement is stopped.

Picture 3.6 shows a graphical presentation of the **Cur**, **Min**, **Avg** and **Max** values.

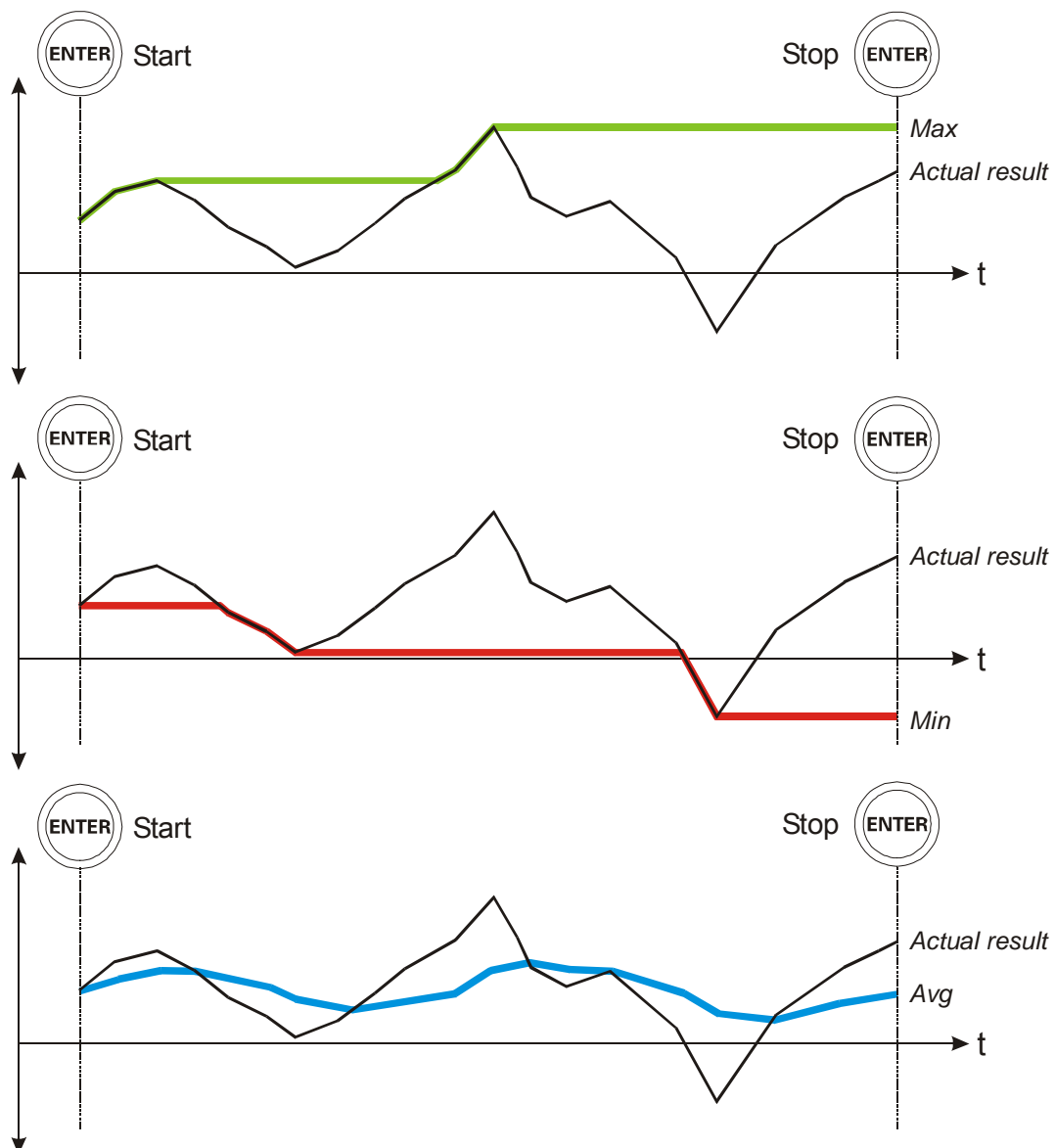

Picture 3.6: **Max**, **Min** and **Avg** values

3.1.5 Displaying single parameter

First select the desired parameter with the \uparrow and \downarrow keys. Then press the F3 (**Single**) key to enable this function which allows you to focus on only one measurement parameter. All values of this single parameter are displayed (**Min, Avg, Max, Cur, Start Time, Stop Time**). Press the F3 (**All**) key to return to display of all measurement parameters. Picture 3.7 shows single parameter displays for air temperature and illumination parameters.

00:00:02	99%	11:15	01.Oct	
Temperature				
Cur	25.1 °C			
Min	25.1 °C			
Avg	25.1 °C			
Max	25.1 °C			
Start:	11:14:34	01.10.04		
Stop:	11:14:36	01.10.04		
		All	Save	

00:00:15	88%	11:16	10.May	
Illumination				
Cur	723.0 lux			
Min	121.4 lux			
Avg	642.5 lux			
Max	730.5 lux			
Start:	11:16:34	10.05.04		
Stop:	11:16:49	10.05.04		
	Hold		All	Save

Picture 3.7: Single measurements

3.1.6 Save function

Press the F4 (**Save**) key to enter **Save menu** (described in chapter 4.2.1) which allows you to store measurements. If measurement is not already stopped, pressing the F4 (**Save**) will automatically stop the measurement.

3.2 Logger mode (Measurements)

3.2.1 Overview

This measuring mode is intended to collect, handle and periodically save measuring data in non volatile memory from all probes that are connected to different instrument measuring ports. Time period between two memorized measurements can be set up between 2 s and 60 min. This data can be downloaded to PC by A1166 LabLink PRO/ A1134 SensorLink PRO (see corresponding user manual). For proper probe connection see the user manual for desired probe.

3.2.2 Description

3.2.2.1 Entering logger mode



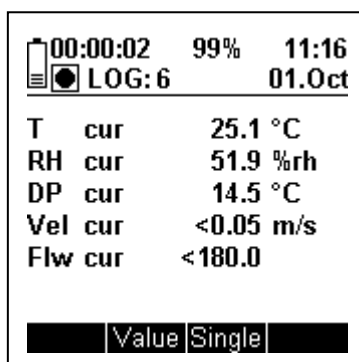

In the normal measuring mode change the function keys to second set by pressing the FUNC key. Then press the F1 (**Logger**) key. Instrument is now in logger mode, caption **LOG** appears in the status window.

Logging procedure saves measurement records into non volatile memory. To define (change) location levels of the logging measurement records press the F4 (**Loc**) key.

In the logger mode the instrument automatically stores all measurements in every logging interval. This interval is set in **Logger settings** (described in chapter 5.5.2). After the measurements are stored, the **Min**, **Max** and **Avg** values are reset and the instrument starts measuring again for the next logging interval.



Picture 3.8: Logging mode – microclimatic probe connected, logging in progress

Instrument starts logging when the  key is pressed. Icon  from normal mode is replaced with icon  in logger mode. The number of concluded intervals is displayed beside the **LOG** caption. For every logging interval the instrument stores all results that can be measured until logging is stopped by pressing the  key.

The F2 (**Value**) key switches between **Min**, **Avg**, **Max** and **Cur** values, as in normal measuring mode. **Min**, **Avg** and **Max** values are cleared at the beginning of each interval, so they are calculated for each interval separately and not for the whole duration of logging. Elapsed time in the upper left corner of the status window also represents elapsed time of each interval and not the whole duration of logging.



Instrument is logging until the  key is pressed again or the memory is full. Instrument can store approximately 4000 values. Table 3.1 shows how long the instrument is logging if the memory is 100% free (cleared) with different logging intervals.

Logging interval	Estimated logging time
2 s	2 hours 15 min
10 s	11 hours
60 s	2 days 20 hours
10 min	28 days
60 min	170 days

Table 3.1: Interval and estimated logging times

If you intend to keep logging for more than just a few hours, it is recommended to use power supply adapter to avoid discharge of the batteries.

3.2.2.2 Back to normal mode

Change the function keys to first set by pressing the  key. Then press the F1 (**Norm**) key to return to the normal mode. Press the  key to reach **Main Menu**.

3.3 Normal measuring mode (Sound)

Instrument has 3 sound measurement submodes. Normal sound level meter (SLM), octave frequency analysis (1/1) and one third octave frequency analysis (1/3).

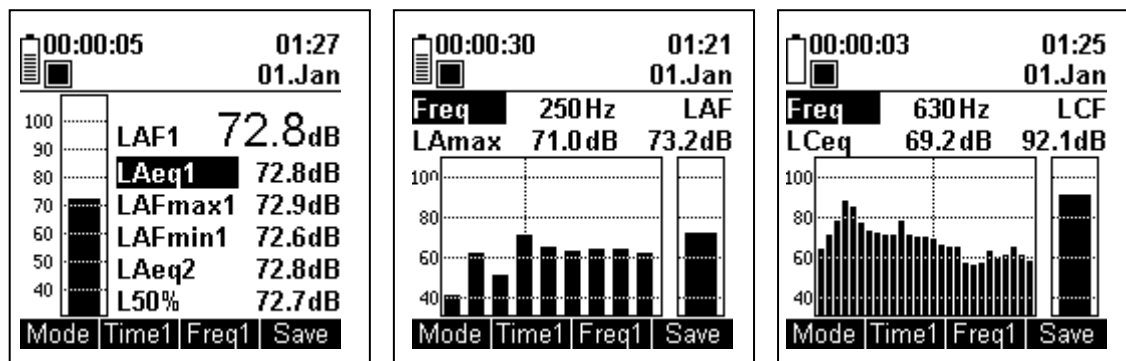

Picture 3.9 Three sound measurement submodes

For more information about sound level measurements see sound probe user manual.

3.4 Logger mode (Sound)

3.4.1 Overview

This measuring mode is intended to collect, handle and periodically save sound level measuring data in non volatile memory. Time period between two memorized measurements can be set up between 2 s and 60 min. This data can be downloaded to PC by A1162 SoundLink PRO / A1167 Soundlink LITE (see corresponding user manual). For all sound level measuring details see the user manual for sound probe.

3.4.2 Description

3.4.2.1 Entering logger mode

In the normal measuring mode change the function keys to second set by pressing the **FUNC** key. Then press the F4 (**Logger**) key. Instrument is now in logger mode, caption **LOG** appears in the status window. Logging procedure saves measurement records into non volatile memory. To define (change) location levels of the logging measurement records press the F4 (**Loc**) key. Logging sound measurements is no different than logging measurements from any other probe.

In the logger mode the instrument automatically stores all measurements in every logging interval. This interval is set in **Logger settings** (described in chapter 5.5.2). After the measurements are stored, all values are reset and the instrument starts measuring again for the next logging interval.

3.4.2.2 Back to normal mode

Press the F1 (**Norm**) key to return to the normal mode. Press the **ESC** key to reach **Main Menu**.

4 Memory management

4.1 Overview

The instrument has enough memory to store approximately 4000 measurement records. Each such measurement record contains:

- All values (**Min, Avg, Max, Cur**) of every probe that was connected at the time of saving the measurement, or at the end of logging interval.
- Some additional information such as the location and time stamp of the measurement is also stored.
- All values from the sound level measurement (including frequency analysis data).

Memory is organised in two levels, each level having 100 different locations. First level represents buildings, and second level represents rooms. Each combination of both levels represents a memory location under which any number of measurements can be stored.

The instrument has a single memory buffer for 4000 measurement records, intended for all measurement modes (normal or logger). When the end of the buffer is reached the instrument searches from the beginning of the buffer if any measurements were deleted, and so there is still some free memory space. But the logger requires coherent free memory space. When it comes to the end of the buffer logging is not possible anymore and memory data should be downloaded to PC and cleared in order to enable logging again.

4.2 Saving measurement records

When memory is completely empty (after clearing both memory and logger) every location is empty and is designated only by number (01-100). After the first measurement is stored in the desired location, it is renamed from a number to a default name (Building 01-100 and Location 01-100) or to an optional name that can be written in special menu (**Rename menu** described in chapter 4.2.2).

Once the location is renamed (to a default or optional name) it keeps its name until all measurements on this location are deleted. If all measurements on certain location are deleted, the location name is also deleted and changed back to a number (01-100). When the next measurement is saved on this location it is again renamed to a default or optional name.

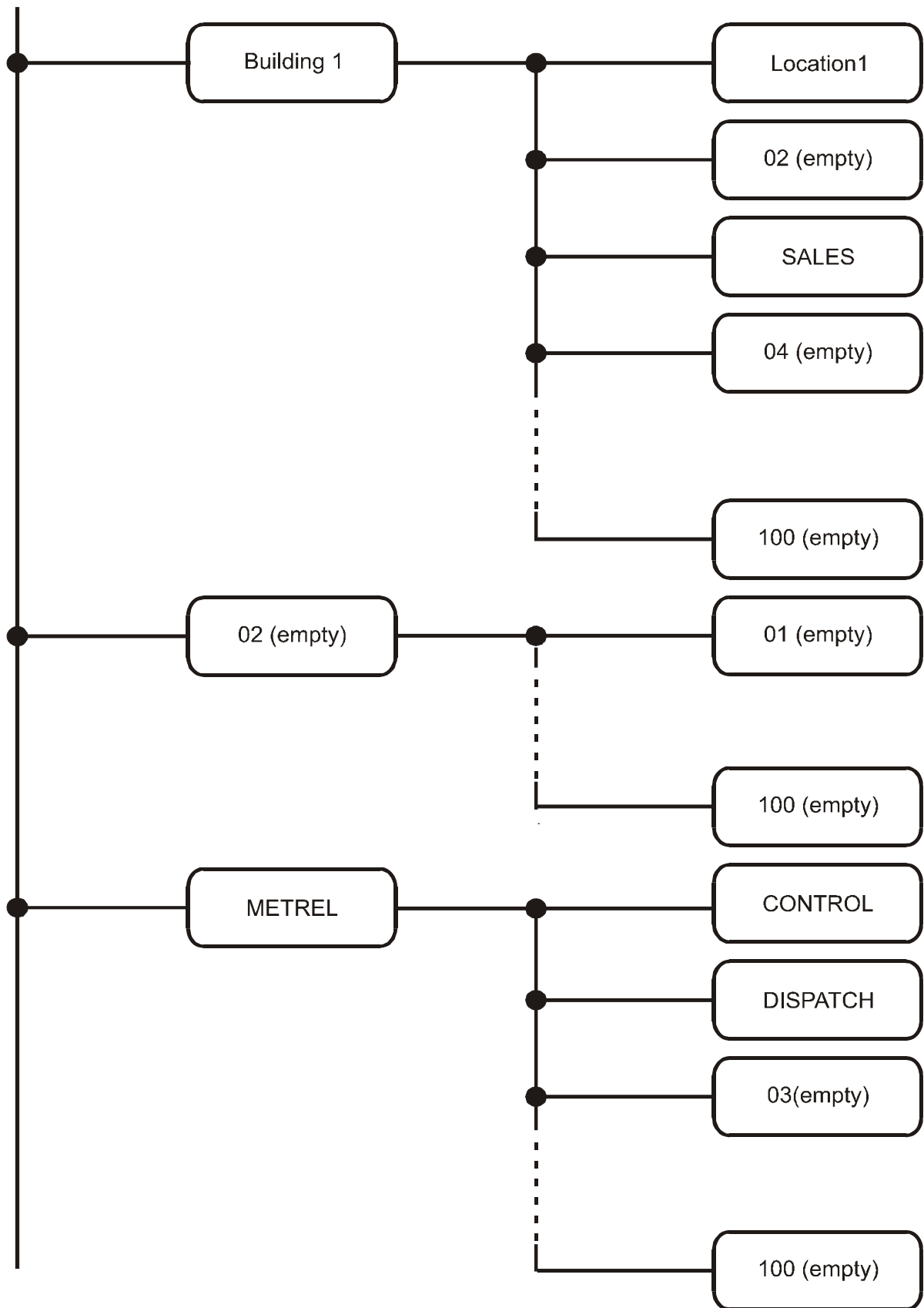

Picture 4.1: Memory structure

4.2.1 Save menu

When in normal measuring mode press the F4 (**Save**) key, and the instrument enters **Save menu**. In **Save menu** (Picture 4.2) one can select on which memory location the measurement result will be saved. Move between **Level1** and **Level2** with the \uparrow and \downarrow keys and select location with the \leftarrow and \rightarrow keys (press and hold for fast rewind). Once memory location is set, it can be renamed in **Rename menu** by pressing the F3 (**Name**) key. Otherwise the default name will be used. By pressing the F4 (**Save**) key, the measurement record is stored on the selected memory location and the instrument returns into normal measuring mode. One can exit **Save menu** without storing any measurements by pressing the ESC key at any time.

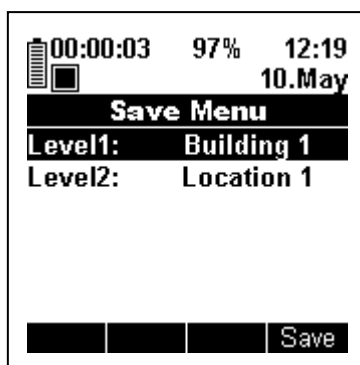

Picture 4.2: Save menu

Note: If the memory level is empty (no measuring results saved under that level), it is designated only by number (01-100). After the first measurement is stored under empty levels, they are renamed from a number to a default name (Level1: Building 01-100 and Level2: Location 01-100) or to an optional name that can be written in special menu (**Rename menu** described in chapter 4.2.2).

4.2.2 Rename menu

Press the F3 (**Name**) key in **Save menu** to reach **Rename menu**. Here one can rename a location. Select a character with the \uparrow , \downarrow , \leftarrow and \rightarrow keys and confirm it with the ENTER key. Use function keys F3 (**Space**) and F4 (**BckSp**) to insert space and to delete characters. Confirm the whole name with the F2 (**O.K.**) key. **Rename menu** is shown in Picture 4.3.

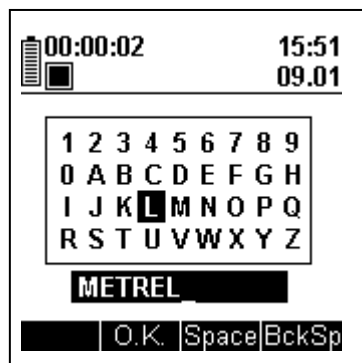

Picture 4.3: Rename menu

In the **Save menu** one can still decide not to save the measurement record, or to save it in different memory location. In that case the location name that was renamed in **Rename menu** is not changed. Location is renamed only if a measurement record is stored in it.



4.3 Recalling normal/multipoint measurement results

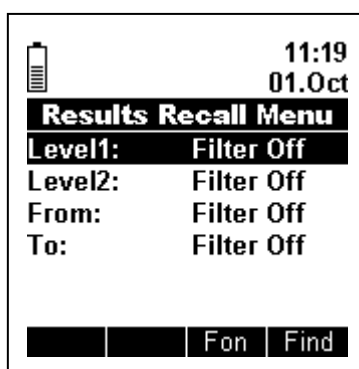

4.3.1 Results recall menu







Choose **Results Recall/Clear** option in **Main menu** and press the  key to enter the **Results recall menu**. Here one can set four different filters in order to select which measurement records are recalled. It is possible to filter measurement records by memory location levels (building, location), start date and stop date. Picture 4.4 shows **Results recall menu**.



Picture 4.4: Memory recall menu

Move between four filters with the  and  keys. By pressing the F3 (**Fon**) key selected filter is enabled.

Select memory location with the  and  keys (press and hold for fast rewind). Setting start and stop date is a bit different and is shown in

Picture 4.5. First select start or stop filter with the  and  keys. Then move to the desired field with the  or  key. Once the field is selected change it with the  and  keys. Parameter that is not inverted is being set, in this case the month.

By pressing the F2 (**Foff**) key the selected filter is disabled, meaning all measurement records regardless of this filter will be found.

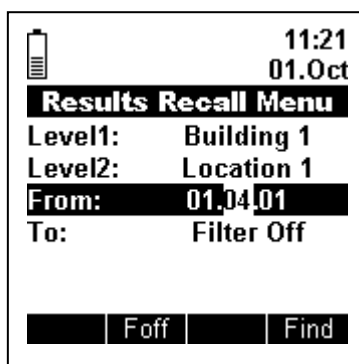

Picture 4.5: Setting start date

4.3.2 Results find menu

By pressing the F4 (**Find**) key in **Results recall menu**, the instrument searches for all measurement records according to filters and goes into **Results find menu**. Here the results of the search are displayed. For every measurement record the memory location where it was stored and the date of the measurement (start date) is displayed. One can browse through results with the \uparrow and \downarrow keys. By pressing the F4 (**View**) key the actual results of a stored measurement are displayed.

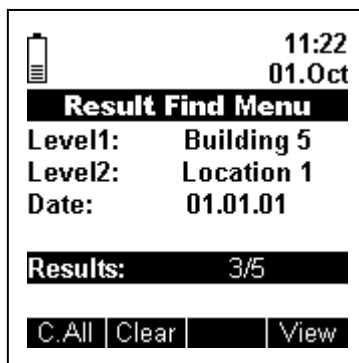

Picture 4.6: Results find menu

4.3.3 Results view menu

By pressing the F4 (**View**) in **Results find menu**, the actual results of recalled measurement record are displayed. The display and the functionality of the keys are the same as in normal measuring mode, except there are no F1 (**Hold**) and F4 (**Save**) keys.

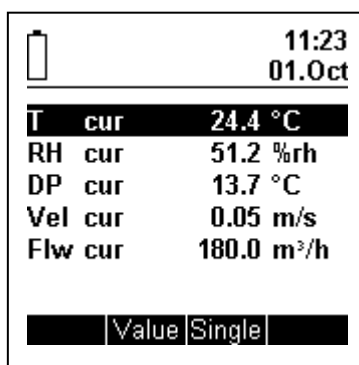

Picture 4.7: Results view menu

4.3.4 Clearing measurement records

It is also possible to delete measurement records in **Results find menu** (Picture 4.6). Press the F2 (**Clear**) key to delete one selected measurement, or the F1 (**C.All**) key to delete all recalled measurement records.



To clear all measurement records set all filters to **Filter Off** with F2 (**Foff**) key in **Results recall menu** and then use the F1 (**C.All**) key in **Memory find menu**. This can also be done more easily in **Results clear menu** (described in chapter 5.4).

4.4 Recalling logged measuring records

4.4.1 Loggers recall menu

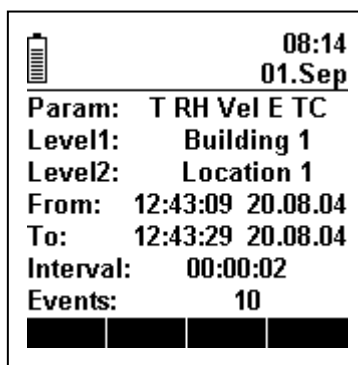
Choose **Loggers Recall/Clear** option in **Main menu** and press the  key to reach **Loggers recall menu**. This menu is completely the same as **Results recall menu** described in chapter 4.3.1. Use the same procedures to filter out which loggers to recall or to delete. The difference is only in **View menu**, where the statistics of the recalled logger records and not the actual record can be displayed. Such statistics is shown in Picture 4.8.



	08:14
	01.Sep
Param:	T RH Vel E TC
Level1:	Building 1
Level2:	Location 1
From:	12:43:09 20.08.04
To:	12:43:29 20.08.04
Interval:	00:00:02
Events:	10
	

Picture 4.8: Statistics of the recalled logger

It is possible to see which measured (not calculated) parameters were logged, on which memory location the logger is stored, start and stop time, logging interval and the number of measuring record that were logged.

5 Settings





5.1 Overview

The intention of the **Settings menu**:

- Change settings for calculation parameters.
- Change logger settings and memory clear option.
- Change instrument settings and view battery supply voltage.

In the following chapters only general settings are explained. Settings regarding calculation parameters that are generated from probe parameters are explained in the correspondent probe user manual.

5.2 Settings menu

Choose **Settings** option in **Main menu** and press the  key to enter. Choose designated option and press the  key again to enter its submenu. Arrows on the left side of the screen indicate that there are more options, which can be reached by scrolling up and down with the  and  keys. Picture 5.1 shows **Settings menu**.

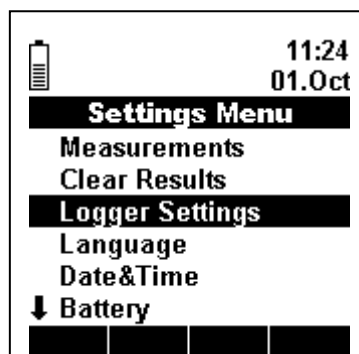





Picture 5.1: Settings Menu.

5.3 Measurements menu



Choose **Measurements** option in **Settings menu** to reach **Measurements menu**. Options in this menu are referred to measured and calculated parameters. These options are described in the user manuals for corresponding probes (except **Units menu**). Select desired option and press the  key to reach its menu.

5.3.1 Units menu

Here one can switch between SI and US units. Select an option with the  and  keys and confirm selection by pressing the  key. Press the  key to exit **Units menu** without changes.

5.4 Memory clear menu

5.4.1 Memory clear menu

Choose **Memory clear** option in **Settings menu** and press the  key to enter **Memory clear menu** (Picture 5.2). Menu shows how much memory is still free and how many measurement records have already been stored. Press the F3 (**Yes**) key to clear the memory. Caption **Clearing** and a bar graph showing the progress in % are displayed. Press the F4 (**No**) or the  key to exit menu without clearing the memory. Note that all measurement records, but no loggers, are deleted with this action. Use **Logger clear menu** to delete loggers (see chapter 5.5.3).

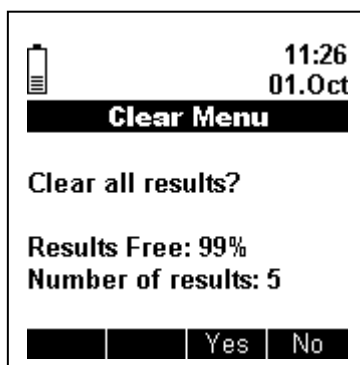





Picture 5.2: Memory clear menu

5.5 Logger menu

5.5.1 General

Choose **Logger Settings** option in **Settings menu** to enter **Logger menu**. There are two options in this menu. Select desired option and press the  key to enter submenu.

5.5.2 Logging interval

Select logging interval with the  and  keys. Note that the interval can only be set in predefined intervals between 2 seconds and 60 minutes. Confirm selection by pressing the  key or exit without changes by pressing the  key.

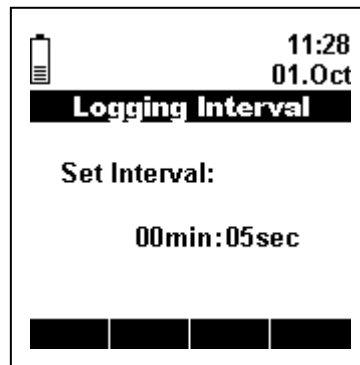

Picture 5.3: Logging Interval menu

5.5.3 Logger clear menu

Menu shows how much logger memory is still free and how many loggers have already been stored. Press the F3 (**Yes**) to clear all loggers. Caption **Clearing** and a bar graph showing the progress in % are displayed. Press the F4 (**No**) or the **ESC** key to exit menu without clearing the loggers.

Note that all loggers, but no saved measuring records, are deleted with this action. Use **Memory clear menu** to delete saved measuring records (see chapter 5.4).

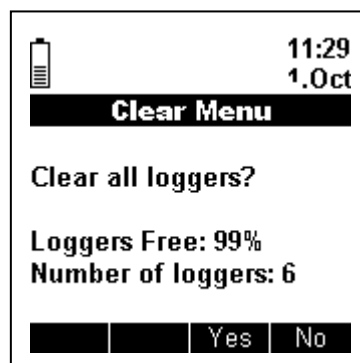

Picture 5.4: Logger clear menu

5.6 Other menus

5.6.1 Language menu

Choose **Language** option in **Settings menu** and press the **ENTER** key to enter **Language menu** (Picture 5.5). Choose between different languages and confirm selection with the **ENTER** or leave the menu without changes with the **ESC** key.



Picture 5.5: Language menu

5.6.2 Date & time menu

Choose **Date&Time** option in **Settings menu** to enter **Date&time menu** (Picture 5.6). Move between days, hours, seconds with the **←** and **→** keys and change the values with the **↑** and **↓** keys. Confirm changes with the **ENTER** key or leave the menu without changes with the **ESC** key.

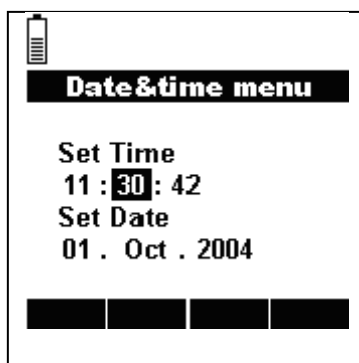

Picture 5.6: Date & time menu

Note: Date and time is running during battery replacement for approx. 10 minutes. If the instrument is without bateries for more than 10 minutes date and time should be set after powering on the instrument.

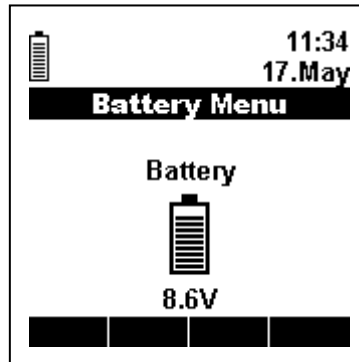

5.6.3 Battery menu

Choose **Battery** option in **Settings menu** and press the  key to enter **Battery menu** (Picture 5.7). Here one can see the actual voltage of the battery. The power supply adapter should not be connected during the battery test to avoid wrong readings of battery voltage!



Picture 5.7: Battery menu.

5.6.4 Contrast menu

Choose **Contrast** option in **Settings menu** and press the  key to enter **Contrast menu** (Picture 5.8). Set the contrast with the  and  keys. Contrast is expressed in percentage and can be changed in steps of 1%.

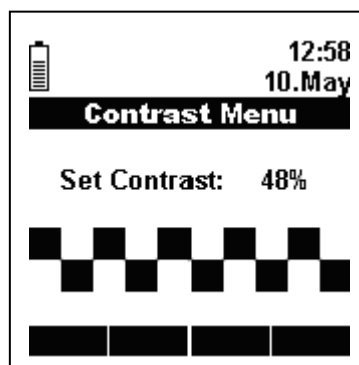

Picture 5.8: Contrast menu

6 Technical data

6.1 Instrument

6.1.1 General

- Communication: RS 232 serial interface for connection to a PC, fully opto isolated, 57600 baud, 9 pin D-type connector.
- Memory: approximately 4000 values
- Logger: approximately 4000 values
- Dimensions (WxHxL): 110 x 85 x 220 mm
- Weight: 0.56 kg (without battery)
- Battery: 6 x 1.2 V AA rechargeable, with internal charger
- Display: graphical LCD with backlight, 160 x 160 dots
- Pollution degree: 2
- Protection degree: IP 40
- *Working temperature range: -10 °C to 50 °C
- *Storage temperature range: - 20 °C to 70 °C
- *Maximum humidity: 95 %RH non-condensing
- Conforms to: Safety: EN/IEC 61010-1
Electromagnetic compatibility (emission and immunity): IEC 61326

***Attention:** This data can be changed regarding the temperature ranges of the battery and the probes.

6.1.2 Universal measuring port 1

- Digital interface
- XLR 5MP connector with custom pin assignment
- Analog voltage measuring input
 - for measuring illuminance with A 1092 probe:

Range	Accuracy
0.01 lux to 19.99 lux	$\pm (0.01 \text{ lux} + 0.5\% \text{ of r.})$
20.0 lux to 199.9 lux	$\pm (0.1 \text{ lux} + 0.5\% \text{ of r.})$
200 lux to 1999 lux	$\pm (1 \text{ lux} + 0.5\% \text{ of r.})$
2000 lux to 20000 lux	$\pm (10 \text{ lux} + 0.5\% \text{ of r.})$

- for measuring luminance with A 1132 probe:

Range	Accuracy
0.1 cd/m ² to 39.9 cd/m ²	$\pm (0.1 \text{ cd/m}^2 + 0.5\% \text{ of r.})$
40 cd/m ² to 399 cd/m ²	$\pm (0.5 \text{ cd/m}^2 + 0.5\% \text{ of r.})$
400 cd/m ² to 3999 cd/m ²	$\pm (1 \text{ cd/m}^2 + 0.5\% \text{ of r.})$
4000 cd/m ² to 40000 cd/m ²	$\pm (10 \text{ cd/m}^2 + 0.5\% \text{ of r.})$

6.1.3 Universal measuring port 2

- Digital interface
- 9 pin D-type connector with custom pin assignment
- 5 V and 18 V supply voltage for probes through probe adapter (A 1144)

6.1.4 Thermocouple measuring port type K

- Standard thermocouple K type input

Range	Accuracy
-200 °C to +1400 °C	$\pm(1.0 \text{ °C} + 0.2\% \text{ of r.})$

6.2 Probe adapter (A 1144)

6.2.1 General

- Dimensions (WxHxL): 30 x 35 x 140 mm
- Weight: 0.07 kg
- Working temperature range: -10 °C to 40 °C
- Storage temperature range: - 20 °C to 70 °C
- Maximum humidity: 95 %RH non-condensing
- Conforms to: Safety: EN 61010-1
Electromagnetic compatibility (emission and immunity): EN 61326

6.2.2 Instrument side:

- Digital interface
- 9 pin D-type connector with custom pin assignment
- 5 V and 18 V supply voltage inputs

6.2.3 Probe side:

- 5 pin Mini XLR connector with custom pin assignment
- Digital interface
- 5 V and 18 V supply voltages for the probes
- Demodulator
- Two analog voltage measuring inputs for measuring temperature and relative humidity:

- Relative humidity:

Range	Accuracy
0 %RH to 100%RH	$\pm 0.1 \text{ %RH}$

- Temperature:

Range	Accuracy
-40 °C to +60 °C	$\pm 0.1 \text{ °C}$